

SYSTEM OVERVIEW

The Telesis UVC is an advanced, Diode-Pumped Solid State (DPSS) laser marking system. The laser beam and Q-switched pulse characteristics are optimized for applications that require high beam quality and stability.

The UVC does an exceptional job of high-speed marking on delicate and sensitive electronics components and medical instruments. These characteristics make it ideal for general purpose laser marking, scribing, trimming, and other material processing applications.

The UVC design features a frequency tripled, Q-switched Nd:YVO₄ laser with an internal diode pump source.

The robust mechanical and optical design allows the Telesis UVC marking head to operate in an industrial environment where shock and vibration are a concern.

The laser marking system offers the following advantages:

- Reliable, long, maintenance-free performance
- Compact size and modular construction
- Exceptional beam quality and stable output power
- Visible aiming diode
- Air cooling
- Active AO Q-switching
- Standard 115/230 VAC operation
- Key switch, Laser Off button, interlocked safety shutter, and emission indicators
- DoD-compliant Unique Identification (UID) marking

SYSTEM CONFIGURATION

The UVC is available in different configurations. The system computer, required for running the Merlin® II LS software, is an external device connected to the laser controller. The system can be configured to mark only stationary objects. It can also be equipped to have the Vari-Z capabilities, which allow marking on multi-height surfaces or angled or cylindrical surfaces.

The modular design allows for major components to be replaced and returned to Telesis if required. The basic laser system includes the following components:

- **Laser Marking Head**—sealed resonator, beam expander, galvanometer assembly, and aiming diode
- **Laser Controller**—electrical components
- **Cable Assemblies**—power, control, and data cables
- **Software**—Merlin II LS laser marking software
- **System Computer**—an external device connected to the laser controller; supplied by Telesis or by the customer
- **Monitor, Keyboard, and Mouse**—components supplied by Telesis or by the customer for external computers

UVC-Series/U15 Laser Marking System

SYSTEM SPECIFICATIONS

Compliance.....	CDRH, CE
Laser Type.....	Diode-pumped, Q-switched, Nd:YVO4
Wavelength	355 nanometers (nm)
Mode	TEM ₀₀
Long Term Output	
Power Drift	< ± 2%
System Power (total) ..	< 400 watts
Power Requirements...	95 to 250 VAC, single- phase, 6A, 50/60 Hz
Maximum Supply	
Voltage	264 VAC
Supply Voltage	
Fluctuation.....	< ±10% with clean ground line
Operational	
Temperature.....	15° to 35°C (65° to 95°F)
Recommended	
Temperature.....	20° to 25°C (68° to 77°F)
Ambient Relative	
Humidity	10% to 85% non- condensing

SYSTEM OPTIONS

- External computer (desktop or notebook with powered CardBus-to-PCI expansion enclosure) to run the Merlin II LS laser marking software
- Laser controller fuse/connector kit
- Remote pushbutton station (start/abort)
- Externally mounted focus finder diode
- Manually operated tool post for vertical (Z-axis) adjustment
- Programmable tool post for vertical (Z-axis) adjustment (requires two-axis controller)
- Rotary drive fixture for rotational (Theta-axis) adjustment (requires two-axis controller)
- Workstation/work area enclosure
- Fume extraction systems
- Vari-Z option

SYSTEM SETUP

The following procedures provide a general overview of the installation process. Refer to the *UVC Installation & Maintenance Manual* for complete installation details.

Do not connect any power cable to a power source until all system connections are made.

1. Ensure all equipment remains powered down and in the OFF position until mounting and connections are complete.
2. Place the laser controller, monitor, keyboard, mouse, and the external system computer in the desired locations. Locate the laser controller as close as practical to the laser marking head.
3. Ensure sufficient clearance exists on all sides of the laser controller to allow for proper air circulation and to permit proper installation of applicable cables. Refer to the *Laser Controller Dimensions* drawings for details.
4. Place the laser marking head on a suitable mounting surface.
5. Ensure sufficient clearance exists on all sides of the laser marking head to allow for proper air circulation and to permit proper installation of applicable cables.
6. Place sufficient fume extraction near the area to be marked. Debris and contamination caused by lasing can damage the laser optics and create chemical hazards.
7. Connect all cables as applicable (laser marking head cable, galvo control cable, computer monitor, keyboard, mouse, and power cables).
8. Connect any optional or customer-supplied devices or interface circuits as applicable.
9. Refer to the *UVC Operation Supplement* for proper startup procedure. Refer to the *Merlin II LS Operating Instructions* for information about the system software.

UVC LASER MARKING HEAD SAFETY LABELS

The following illustration shows the labels and their locations on the UVC Laser Marking Head. Familiarize yourself with the laser labels and their locations prior to operating the laser marking system.

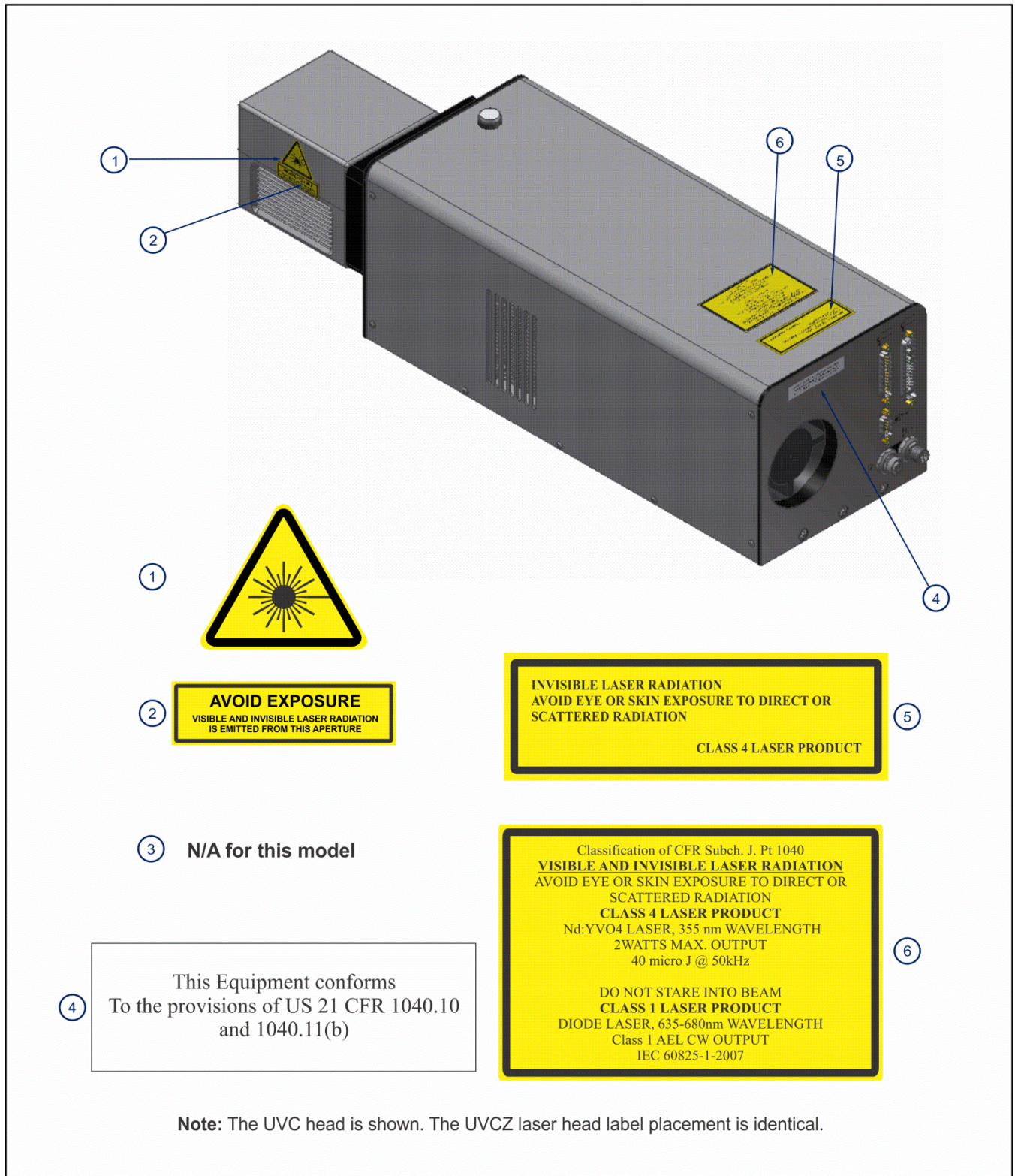

UVC-Series/U15 Laser Marking System

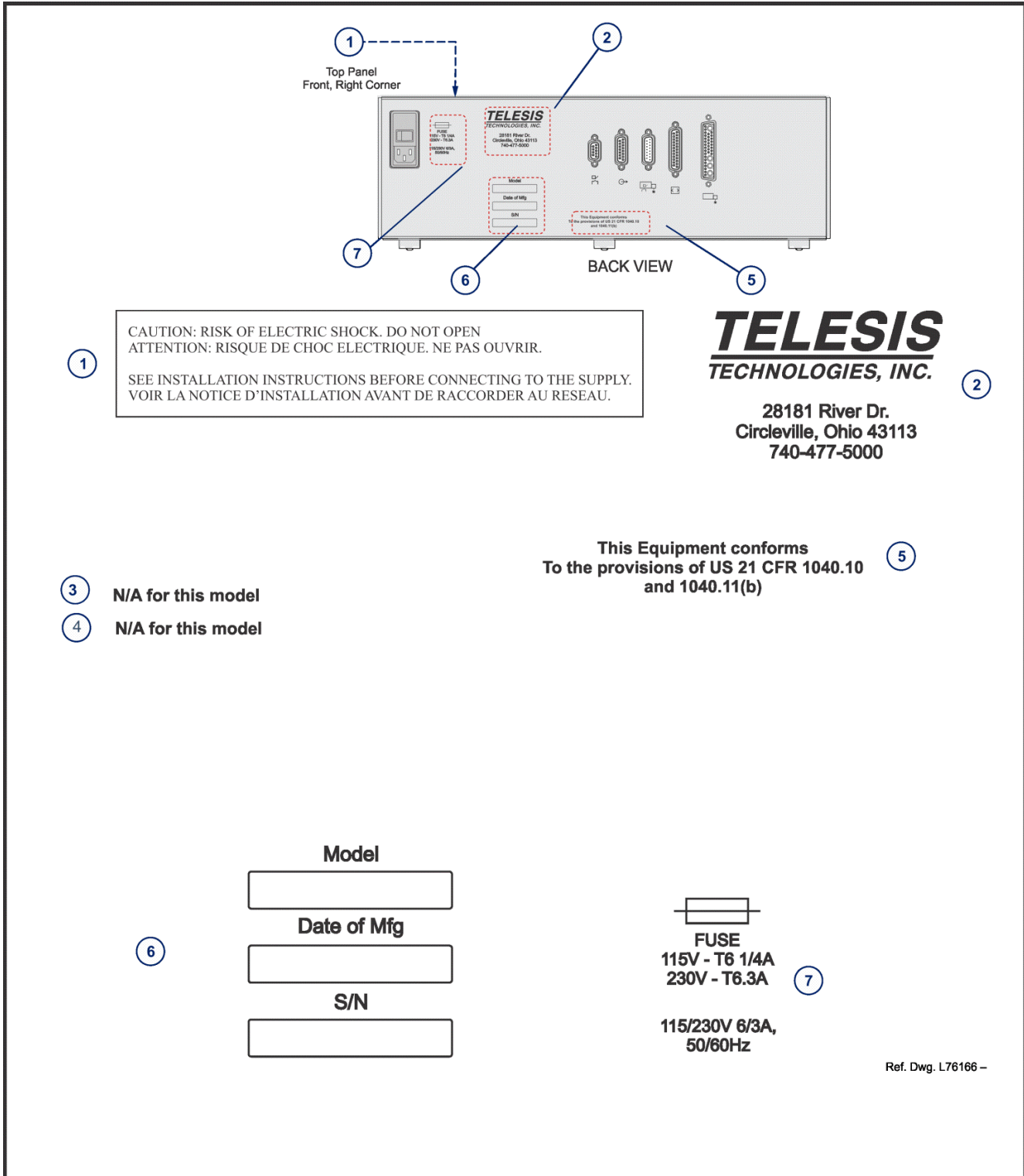

U15 Laser Controller External Labels

UVC-Series/U15 Laser Marking System

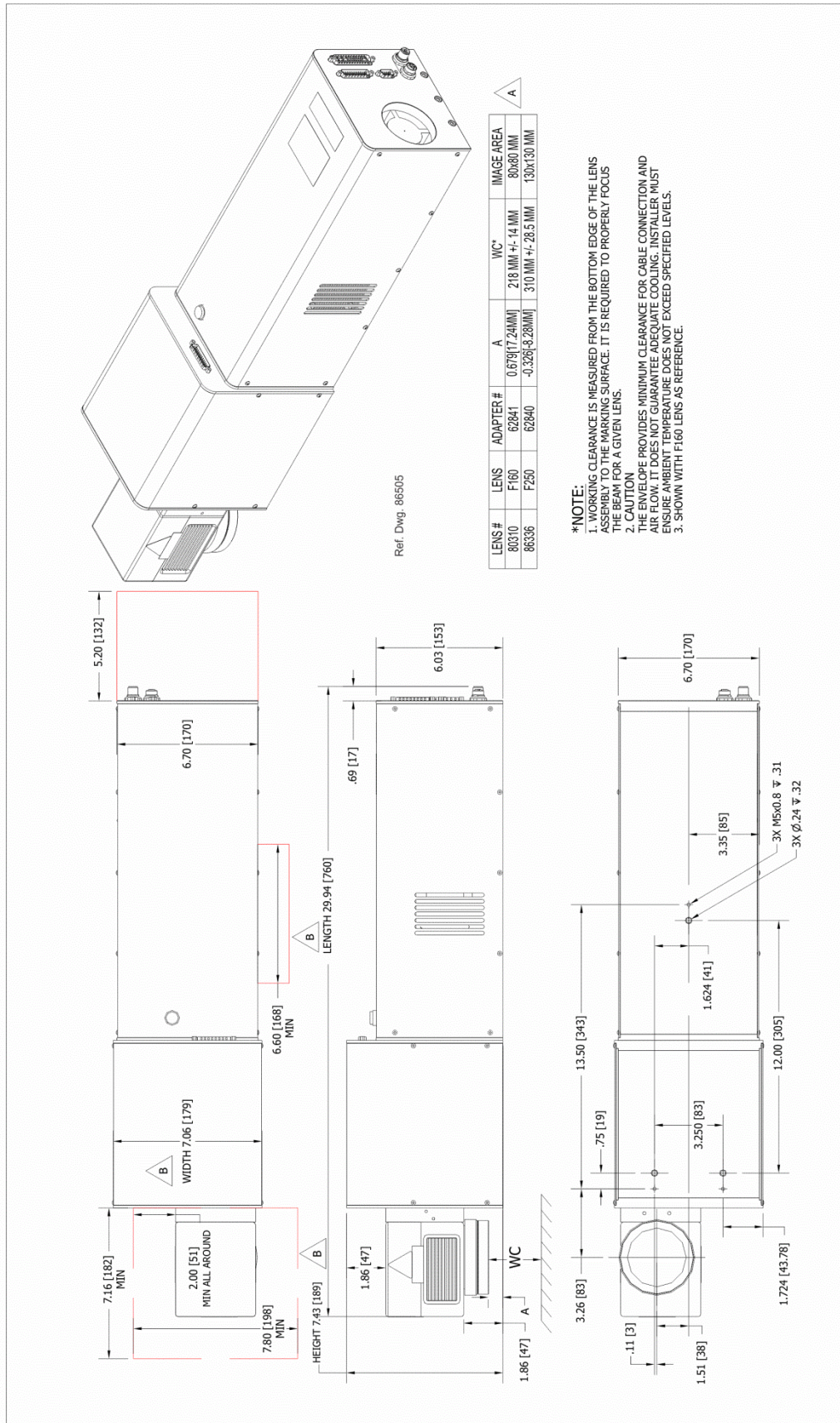

UVCZ Laser Marking Head Installation Drawing

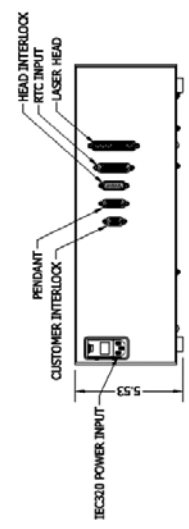
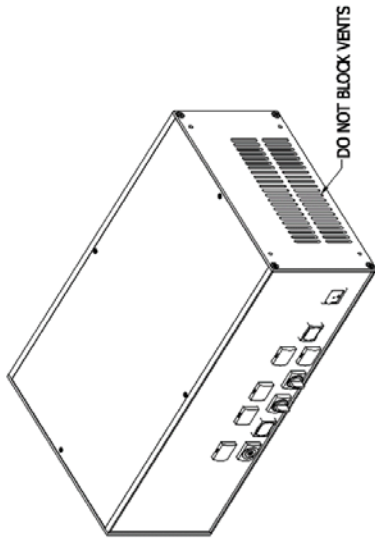

Ref. ENG 7986-

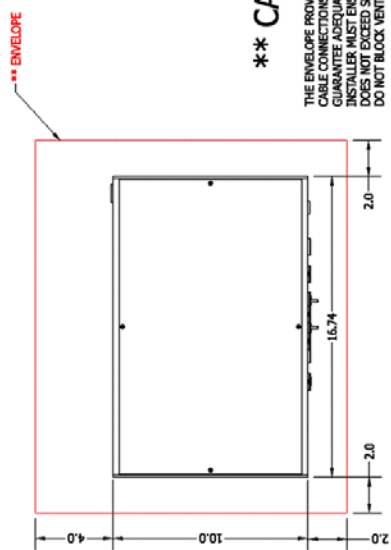

**** CAUTION**

THE ENVELOPE PROVIDES MINIMUM CLEARANCE FOR CABLE CONNECTIONS AND AIR FLOW. IT DOES NOT PROTECT THE ENVELOPE FROM DAMAGE. THE INSTALLER MUST INSURE AMBIENT TEMPERATURE DOES NOT EXCEED SPECIFIED LEVELS. DO NOT BLOCK VENTS.

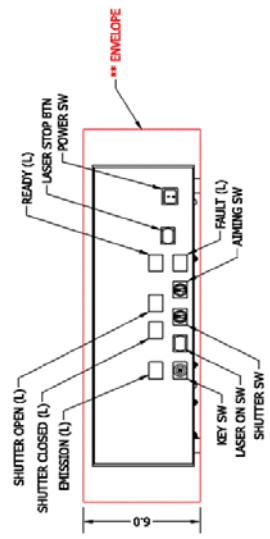

U15 Controller Installation Drawing

UVC-Series/U15 Laser Marking System

U15 Controller Specifications

Dimensions (W x H x D) 425.19 x 140.46 x 254 mm
 16.74 x 5.53 x 10.00 in

Surrounding Envelope ... See *U15 Laser Controller Dimensions* drawing

Weight (approximate).... 6.803 kg (15 lb)

Cooling..... Air cooled, fan

Operator Control Panel

The front panel control module includes the System Key switch, laser off push button, manual safety shutter control, function indicators, and laser stop.

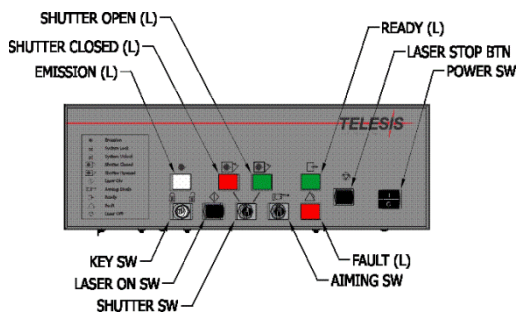

UVC LASER MARKING HEAD

UVC lasers are designed for easy maintenance. A heat exhaust fan is located on the rear of the unit. The laser marking head encloses the sealed laser resonator, the beam expander, the visible (red beam) aiming diode, and the galvanometer assembly.

UVC Laser Marking Head Specifications

Dimensions (L x W x H)

UVC Head..... 560 x 170 x 153 mm
 (22.06 x 6.70 x 6.03 in)

UVCZ Head..... 760 x 179 x 189 mm
 (29.94 x 7.06 x 7.43 in)

Head Height with Lens

UVC Heads F103 lens: 153 mm (6.03 in)

F160 lens: 170 mm (6.69 in)

F250 lens: 153 mm (6.03 in)

F255 lens: 153 mm (6.03 in)

UVCZ Heads. F160 lens: 206.24 mm
 (8.12 in)

F250 lens: 189 mm (7.44 in)

Surrounding Envelope . See *UVC or UVCZ Laser Marking Head Dimensions* drawing

Electrical Power 225 watts (approximate)

Mounting Weight (approximate)

UVC 14.5 kg (32 lb)

UVCZ 20.8 kg (46 lb)

Mounting..... Three M5-0.80 mounting bolts or three 0.2362P6 locating pins

Positioning Visible (red) aiming diode

Field Resolution 16 bit (65535 data points)

Galvanometer

Repeatability < 22 micro radian

Marking Field Size Lens-dependent, see chart

Cooling Air cooled

Dual-Sensor Shutter Circuit

The laser marking head employs a dual sensor to detect the closed state of the laser shutter mechanism. The sensor signals can be monitored at the Outputs connector on the back panel of the laser head.

Sealed Laser Resonator

The laser resonator is assembled and sealed in the clean room environment to prevent contamination. The laser marking head contains an electro-mechanical safety shutter. Under power, the safety shutter allows the laser beam to pass through the galvanometer steering mirrors. If the shutter is closed during normal operation (or power is removed from the system via a power off/stop condition), it will block the 355 nm laser beam.

Visible Aiming Diode

The laser marking head produces a visible beam aiming diode that can be viewed on the work surface without the need for protective safety goggles. This provides a safe and convenient aid for laser setup and part programming. Because the aiming diode is located *after* the shutter, the visible beam can be used with the shutter opened or closed. Additionally, the aiming beam can be used with the lasing beam during the marking cycle. **Note that protective eyewear must always be worn when the laser is in operation.**

Marking Field Size

The size of the marking field depends on the lens installed on the laser marking head. See *Flat-Field Lens*.

Marking Depth

Simple laser parameters can be operator-programmed to create depths ranging from simple surface discoloration, shallow laser etching, or deep laser engraving. Marking depth depends on several factors, including material, lens selected, and laser marking parameters. Contact Telesis for the proper setting for your specific application.

Flat-Field Lens

The flat-field lens is key to the marking performance of the system. This is the final coated optical lens the beam passes through before it strikes the marking target.

This lens is called a *flat-field lens* because when the beam is focused, the focus lies in a plane perpendicular to the optical axis of the lens. To protect the final objective lens from dust and debris, a clear protective cover is inserted between the work area and the lens.

The installation drawings on pages 5 and 6 outline the available lenses, the resulting image field (marking window) provided by the lens, and the working clearance (in millimeters) to properly focus the laser for marking.

SYSTEM COMPUTER

The laser system requires an IBM-compatible computer for running the Merlin II LS laser marking software. The system computer can be an external device connected to the laser controller, or it can be embedded within the controller.

NOTICE

Merlin II LS software and associated applications are pre-installed on the embedded computer.

All system computers supplied by Telesis have the Laser/Galvo Controller Board and the Merlin II LS software installed prior to shipment so the entire assembly is tested as a laser marking system. Warranties for the computer, keyboard, monitor, and peripherals default to the original equipment manufacturer.

If the external system computer is supplied by anyone other than Telesis, it must use the following software:

Operating System	Windows® XP-Sp3, 7, 8, 10 (32b or 64b)
Operator Interface	Telesis Merlin II LS laser marking software

Additionally the system computer must, at a minimum, meet the following specifications:

Processor	Intel Core with RAM as recommended per operating system
Hard Drive	2 GB hard disk drive
Comm Ports	one available RS-232 serial port two available USB ports two available Ethernet ports two available full-height PCIe x4 slots ¹
Circuit Cards.....	Laser/Galvo Controller Board, Video Board

UVC-Series/U15 Laser Marking System

- Peripherals..... SVGA Color Monitor, Mouse², Keyboard²
- 1) One additional PCI or PCIe slot required if system is configured for mark-on-the-fly operation. If the system computer is a notebook, expansion must be used to provide the PCI slots.
 - 2) Telesis recommends a USB mouse and a USB keyboard for system computers that are embedded in the laser controller.

SYSTEM SOFTWARE

The powerful Telesis Merlin II LS laser marking software is a Windows® based software package that comes standard with the laser marking system. It is a graphical user interface that makes marking pattern design quick and easy. The WYSIWYG (what-you-see-is-what-you-get) interface provides a to-scale image of the pattern as it is created. "Click and drag" to adjust the field size, location, or orientation.

The Merlin II LS software includes tools to create and edit text at any angle, arc text, rectangles, circles, ellipses, and lines. Multiple fields can be grouped and saved as a block to form a logo. Existing DXF files can also be imported for marking. Non-printable fields can be created to clearly display a graphical representation of the part being marked.

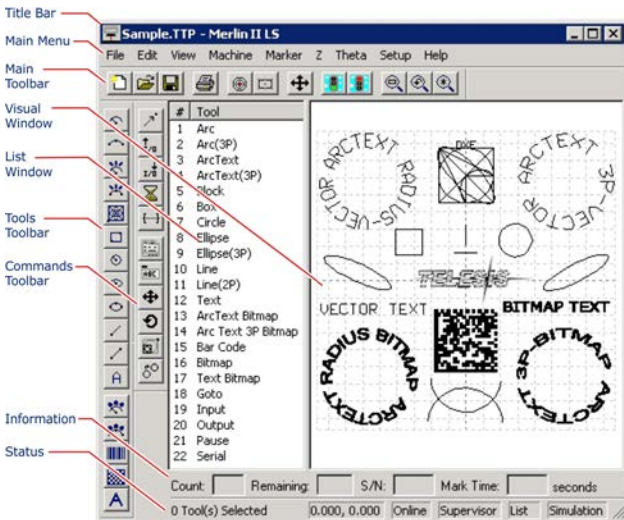

Merlin II LS User Interface

Merlin II LS Laser Marking Software Specifications

- Font Generation..... True Type Fonts
- Barcodes and Matrix. 2D Data Matrix, PDF417, BC 39, Interleaved 2 of 5, UPCA/UPCE BC 128, Maxi Code, Code 93, QR Code, and others
- Graphic Formats Raster and Vector: BMP, GIF, JPG, WMF, EMF, DXF, CUR, ICO
- Serialization Automatic and Manual Input Host Interface Capable
- Linear Marking..... Scalable with Letter Spacing Control
- Arc Text Marking..... Scalable and Adjustable
- Drawing Tools..... Line, Rectangle, Circle, Ellipse

Remote Communications

The communication capability of the laser marking software allows you to control the laser from a remote source. Remote communications can be performed by connecting to a host computer or an optional two-axis auxiliary controller or to remote I/O devices.

Host Communications. Remote communications can be executed from a host computer using RS-232 or Ethernet (TCP/IP) connections to the system computer running the Telesis laser marking software. The software provides parameters to define the data transmitted to and from the host. For more information on using and configuring these parameters, refer to the *Merlin II LS Operating Instructions*.

Two-Axis Controller. Telesis offers an optional two-axis controller for all laser systems that use the Merlin II LS laser marking software. The auxiliary controller provides an interface for connecting a Z-axis tool post or a Theta-axis rotary drive unit. An optional board allows connection of two additional linear axes. For installation details, refer to the *Auxiliary Controller Installation & Maintenance Manual* supplied with the two-axis controller.

I/O Kits for Systems with External Computers.

Telesis offers optional I/O kits that provide up to 12 additional, programmable I/O signals (6 inputs and 6 outputs). All kits provide an I/O card, pre-installed SIPs resistor packs, and software driver medium. For details on connecting and using the additional I/O signals, refer to the *Installation Supplement* provided in each of the kits.

- **Kit 53920**⁽¹⁾ provides a PCI-DIO24 card.
- **Kit 53928**⁽²⁾ provides a PCI-DIO24 card, the Merlin I/O Interface Module, and two cable assemblies.
- **Kit 74445**⁽¹⁾ provides a PCIe-DIO24 card (PCIe x1).
- **Kit 53928**⁽²⁾ provides a PCIe-DIO24 card (PCIe x1), the Merlin I/O Interface Module, and two cable assemblies.

⁽¹⁾ *This kit does not provide opto-isolated signals. Telesis does not endorse direct connection of I/O signals to the I/O board. Direct connections to high current/high voltage devices will damage the board.*

⁽²⁾ *When using the Merlin I/O Interface Module in this kit, additional I/O racks or opto-isolated board assemblies are not required.*

Communications Protocols

Two types of host interface (RS-232 or TCP/IP) are supported and two communication protocols (Programmable and Extended) are provided through the Merlin II LS laser marking software.

Programmable Protocol. Programmable protocol provides one-way (receive only) communication with no error checking or acknowledgment of the transmitted data. You can use Programmable Protocol to extract a continuous portion of a message string to print. This can be used with a host computer or a bar code scanner. Note that XON/XOFF Protocol applies even when Programmable Protocol is selected.

The Programmable Protocol Message Type identifies the type of message sent from the host and determines how the marker uses the data it extracts from the host message string when Programmable Protocol is used.

- 49 Message type 49** (ASCII 1) overwrites the content of the first text-based field in the pattern with the data extracted from the host message. Note that if the field contains message flags, they will be overwritten, not updated.
- 65 Message type 65** (ASCII A) updates the Offset Angle parameter with the data extracted from the host message. Syntax for the transmitted string is $\pm n$, where \pm is a positive or negative sign and n is an integer that represents the offset angle for the marking window.

- 72 Message type 72** (ASCII H) updates the Offset X/Y parameters with the data extracted from the host message. Syntax for the transmitted string is $\pm X.X, \pm Y.Y$; where \pm is a positive or negative sign, $X.X$ represents the X-axis offset distance, and $Y.Y$ represents the Y-axis offset distance.
- 80 Message type 80** (ASCII P) indicates the data extracted from the host message is the name of the pattern to be loaded.
- 81 Message type 81** (ASCII Q) updates the text in the first query text buffer (buffer 0) with the data extracted from the host message.
- 86 Message type 86** (ASCII uppercase V) updates the text in the first variable text field in the pattern with the data extracted from the host message.
- 118 Message type 118** (ASCII lowercase v) updates the first text field encountered in the pattern that contains a variable text flag that matches the specified string length.
- 0 Message type 0** (zero) indicates the host will provide the message type, field number (if applicable), and data. This delegates message type selection to the host on a message-by-message basis. The host message must use the format:
Tnn<string>

where:

T = the message type (1, A, H, P, Q, V, or v)

nn = the two-digit field number or query text buffer where data will be placed.

Note: Not used with message types A, H, or P.

<string> = the pattern name to load (Message Type P) or the data to be inserted into the field or the query text buffer (message types 1, Q, V, or v).

UVC-Series/U15 Laser Marking System

Extended Protocol. Extended Protocol provides two-way communication with error checking and transmission acknowledgment. It is designed to provide secure communications with an intelligent host device using pre-defined message formats and response formats where serial communication is a vital part of the marking operation.

All communications are carried out in a parent-child relationship, with the host being the parent. Only the host can initiate communications. The Extended Protocol message is transmitted using the following format:

SOH TYPE [##] STX [DATA] ETX BCC CR

TYPE The message type is defined by a single, printable ASCII character. The Extend Protocol message types are:

- 1 Message Type 1** is not recommended for use. Use Message Type V when possible. If Message Type 1 is needed, contact your Telesis Technologies representative.
- A Message Type A** provides data to the system Offset Angle parameter for the marking window or polls the system for data.
- E Message Type E** allows the host to take the machine offline. It also provides the option of displaying an error message box with the provided data string.
- G Message Type G** initiates a print cycle.
- H Message Type H** provides data to the system X/Y Offset parameters or polls the system for data.
- I Message Type I** polls the system for the I/O status.
- M Message Type M** sets the current Omni Serial Number to the integer value in the message data.
- O Message Type O** places the marker online. This allows a host computer to reset. For example, this can be used to recover from a power outage when the marker is unattended.
- P Message Type P** loads a pattern or polls the system for the current pattern name.
- R Message Type R** allows a rotation angle to be specified via the host to rotate all pattern objects about the window origin.
- Q Message Type Q** provides data to the system query text buffer or polls the system for data.
- S Message Type S** polls the system for the machine status. The machine status is returned to the host in an eight-character hexadecimal mask.
- V Message Type V** provides data to a variable text string in the pattern or polls the pattern for data.
- X Message Type X** sets the current Pattern Serial Number to the integer value in the message data.

TRADEMARKS

Telesis and **Merlin** are registered trademarks of Telesis Technologies, Inc. in the United States and/or other countries.

Pentium is a registered trademark of Intel Corporation in the United States and other countries.

Windows and **Vista** are registered trademarks of Microsoft Corporation in the United States and other countries.